

Inductive Sensors
BES 515-326-BO-C-PU-05
M18x1 x 76.5
normally-open
Sn=5mm
shielded

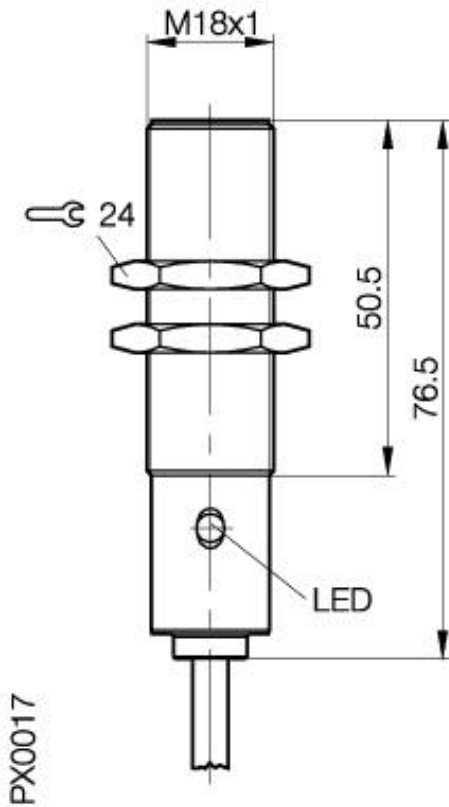

Common Data

Product name	Proxinox
Mounting in steel	shielded
Rated operating distance Sn	5mm
Assured operating distance Sa	0...4.0mm
Repeatability R	≤ 5%
Hysteresis	≤ 15%
Function indication	yes
Ambient temperature range	-40...+85°C
Polution Degree	3
Time delay before availability	≤ 10ms

Mechanical Data

Measurements BxHxT or DxT	M18x1 x 76.5mm
Housing material	1.4305
Material of sensing face	PA 12
Degree of protection	IP68 acc. BWN Pr 20IP
Connection	Cable
Cable type	LifY-Y-11Y-O
Schock: Halfsinus, 30 gn, 11ms	
Vibration: 55 Hz, 1mm Amplitude, 3 x 30 Minutes	

Electrical Data

Current type	DC
Wiring	3-Wire
switching function	normally-open
Output signal	PNP
Rated operational voltage	24 DCV
Rated operational current	200mA
Supply voltage	10...30 DCV
Ripple	≤ 15%
max. switching frequency	900Hz
No-load supply current	≤ 12/≤ 4mA
Off-state current	≤ 10µA
Voltage drop	≤ 1.5/-V
Short circuit protection	yes
Protected against polarity reversal	yes

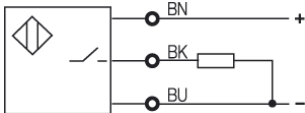

Utilization categories
 Insulation class

DC 13
 II

Datasheet number:

Definitions see general catalog.
 If not otherwise noted, ratings according to
 IEC 60947-5-2 (DIN EN60947-5-2)

Balluff GmbH
 Schurwaldstrasse 9
 73765 Neuhausen a.d.F.
 Phone (07158) 173-0 Fax (07158) 5010

Datenblatt by CD-ROM - 04/2007

BALLUFF
 sensors worldwide